

smonet



SMART LOCK

Model: M6-BF

User Manual

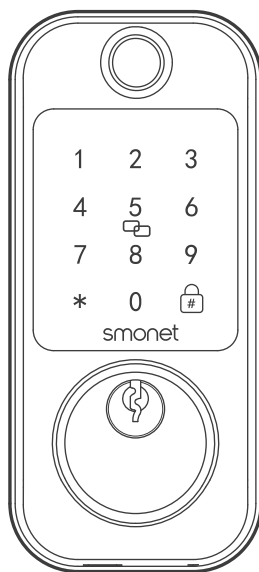

Read and Save the Instructions



Scan Me

Installation Video



Smart Life App



Contents

In the Box	01
Product Overview	02
Preparation	03
Check Your Door Dimensions	03
Installation	04
Install the Latch	04
Install the Strike Plate	05
Install the Exterior Assembly	06
Install the Mounting Plate	07
Install the Interior Assembly	08
Insert the Batteries	09
Test the Lock	10
Using the App	11
Create an Account	11
Pair Your Phone with the Smart Lock	11
Determine the Door Opening Direction	12
Change the Admin Passcode	12
APP Homepage Overview	13
Basic Operations	17
Unlock the Door	17
Lock the Door	17
How to Reset the Lock	18
Smart Home Integration	19
Enable the Gateway	19
Enable the Amazon Alexa	21
Enable the Google Home	23
FAQs	24
Smart Lock Table	24
Customer Service	25



In the box

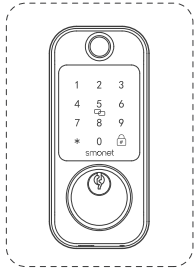

Exterior Assembly

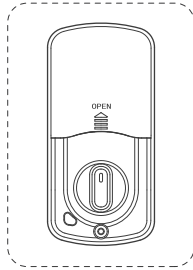

Interior Assembly

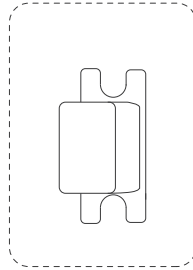

Strike Box

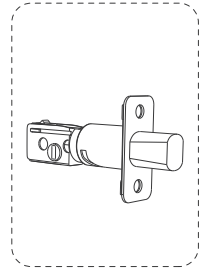

Deadbolt

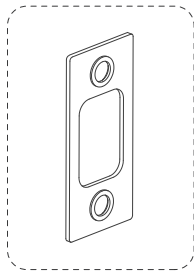

Strike Plate

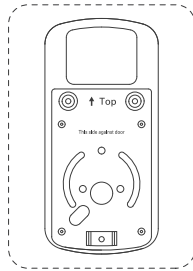

Mounting Plate

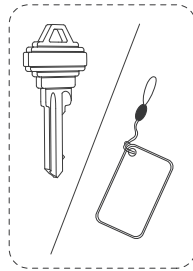

Key & IC Card

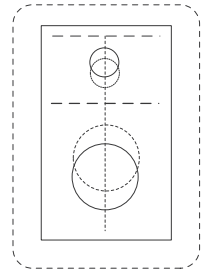

Drilling Template

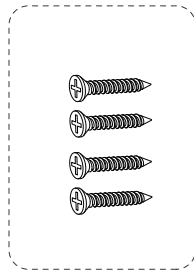

Deadbolt /
Strike Screws

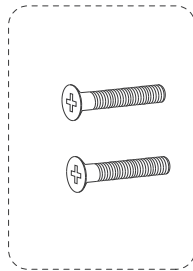

Mounting Plate
Screws

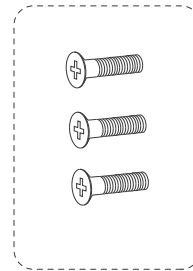

Interior Assembly
Screws

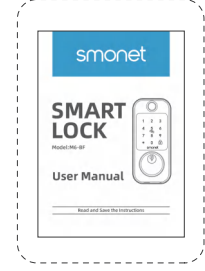

User Manual



Product Overview

Front

Fingerprint Sensor

Touchscreen

Keypad

IC Card Sensor

Keyhole

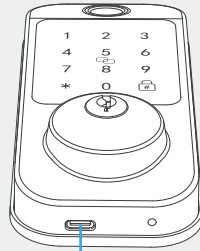
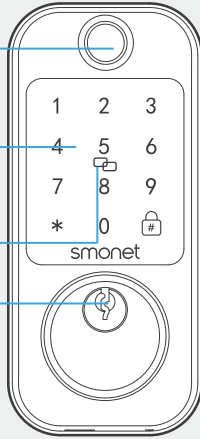

USB-C Port

Connect a power bank for temporary power supply if the batteries run out.

Rear

Battery Cover

Knob

Double Locking Button

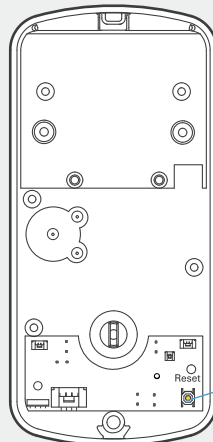
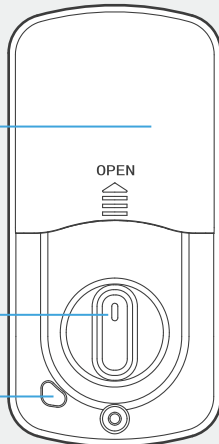

Reset Button



Preparation

Check Your Door Dimensions

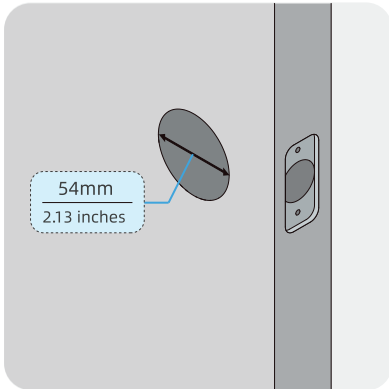

Cross bore diameter: 54 mm
(2.13 inches).

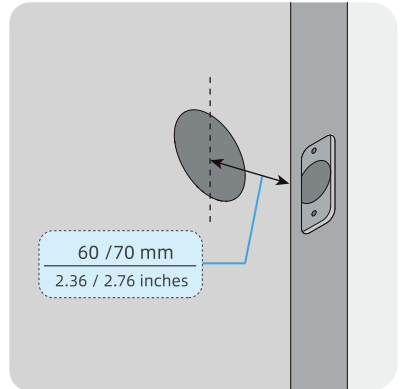

Backset: 60 / 70 mm
(2.36 / 2.76 inches).

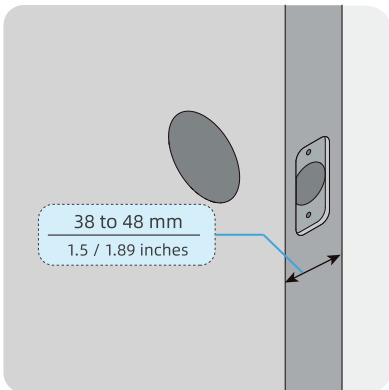

Door thickness: 38 to 48 mm
(1.5 / 1.89 inches).

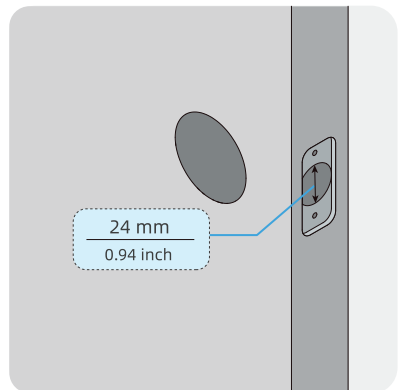

Edge bore diameter: 24 mm
(0.94 inch).



Installation

Step 1. Install the deadbolt

(1) If your door has a 60mm/2 $\frac{3}{8}$ " backset, you can install the deadbolt without any adjustments

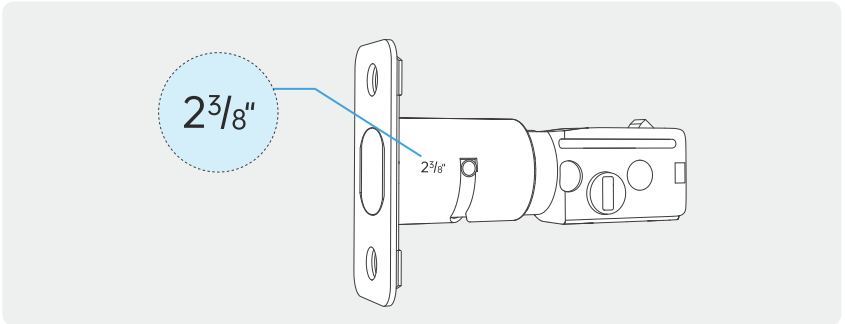

(2) For doors with a 70mm/2 $\frac{3}{4}$ " backset, rotate the deadbolt upwards to extend its length.

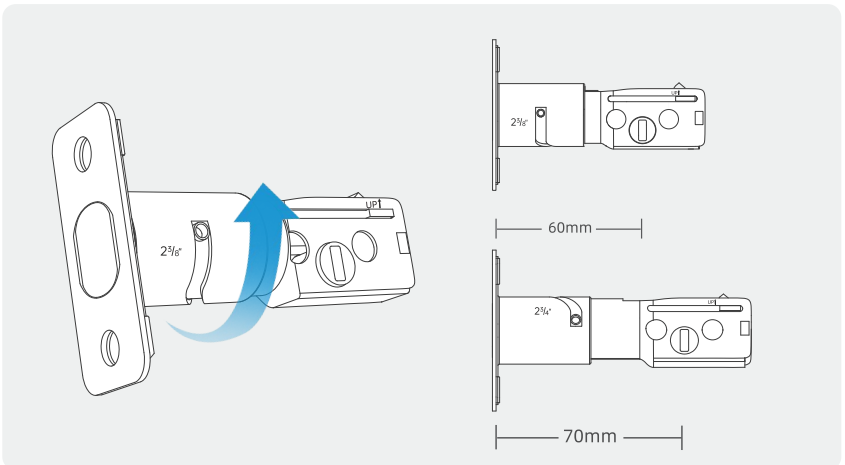



- Insert the retracted deadbolt with the word “UP” and up arrow facing upwards.

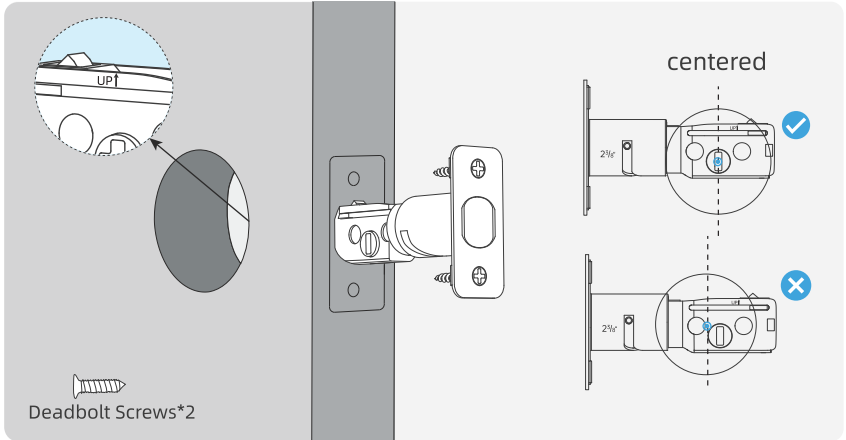

- Screw the deadbolt with a screwdriver (not provided).

Parts Required: Deadbolt, Deadbolt Screws, Screwdriver (not provided)

Step 2. Install the Strike Plate

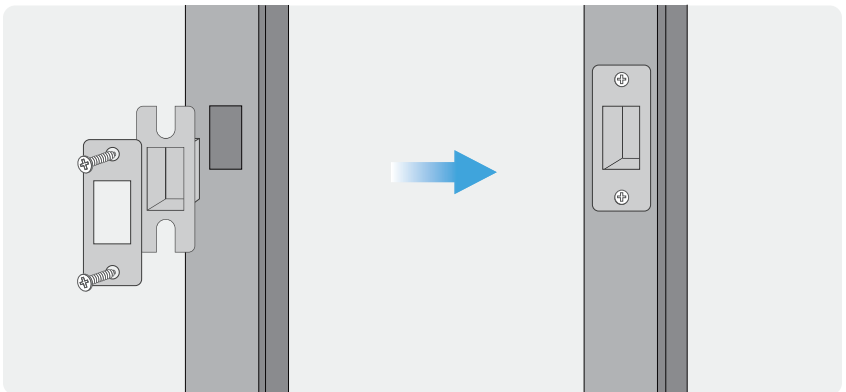

Parts Required: Strike Plate, Strike Pad, Strike Screws, Screwdriver



Step 3. Install the Exterior Assembly

- (1) Place the spindle **vertically** before inserting it.
- (2) Turn the spindle several times to test whether the deadbolt extends or retracts smoothly.
- (3) Keep the spindle **vertical** and pass the cable under the deadbolt.

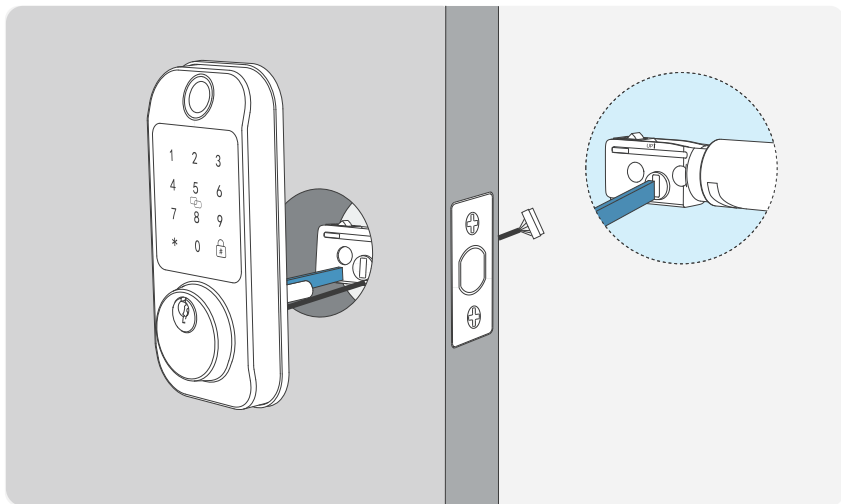

Note: Keep the deadbolt retracted (in unlocked status) and do not insert any keys during installation.

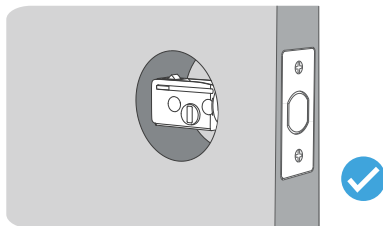
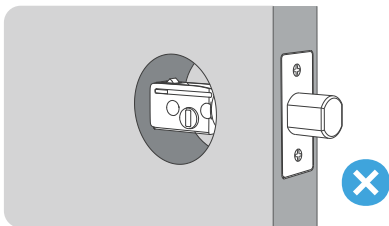

Parts Required: Exterior Assembly



Step 4. Install the Mounting Plate

- (1) Pass the spindle through the central hole and the cable through the right bottom hole. The side with the words “Cable Hole” should face outside.
- (2) Screw the mounting plate firmly while ensuring proper alignment.

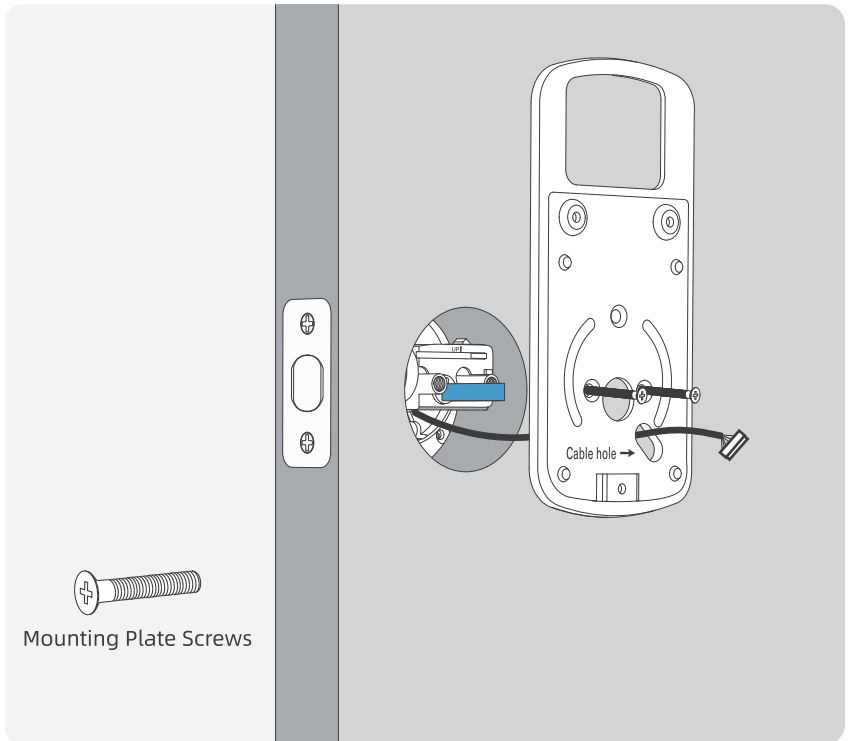

Note: Please keep the exterior assembly straight when installing the mounting plate.

Parts Required: Mounting plate, Mounting Plate Screws, Screwdriver



Step 5. Install the Interior Assembly

(1) Plug the cable into the port and put the excess cable into the hole. Make sure the connector is securely matched with the pins.

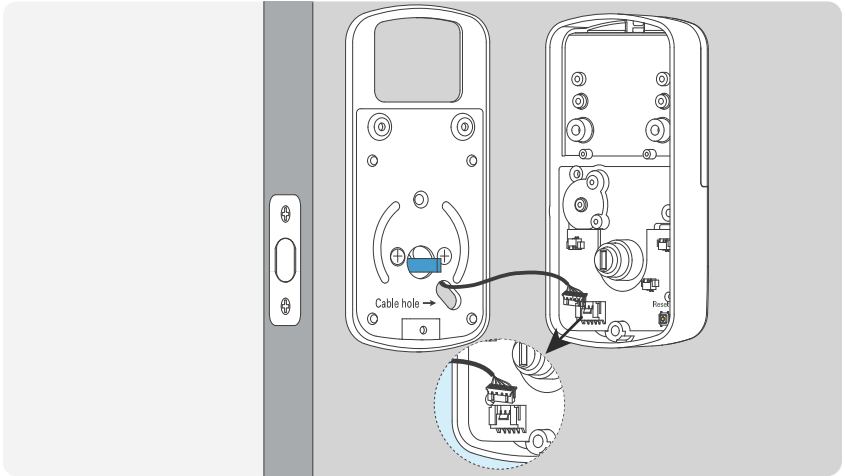

(2) Tighten the screws into the interior assembly.

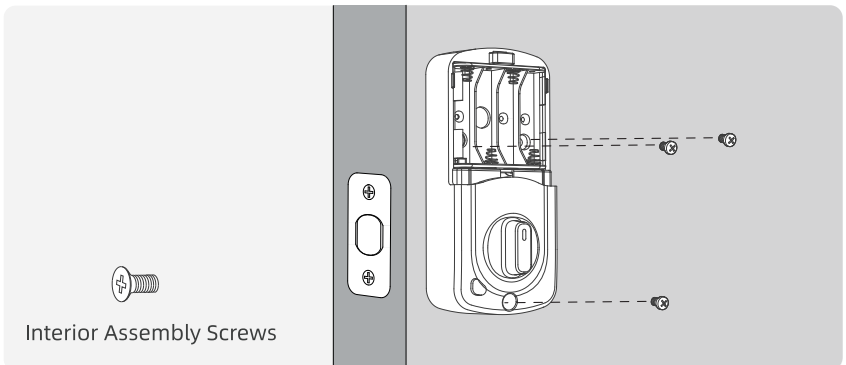

Parts Required: Interior Assembly, Interior Assembly Screws, Screwdriver



Step 5. Install the Interior Assembly

Note: Only use new, non-rechargeable alkaline batteries.

(1) Slide the cover up and insert 4 AA alkaline batteries.

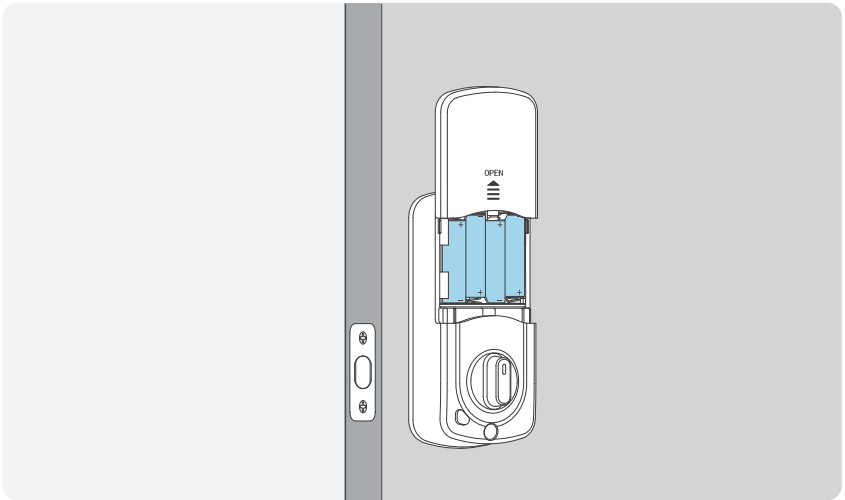

(2) Slide the cover back into place

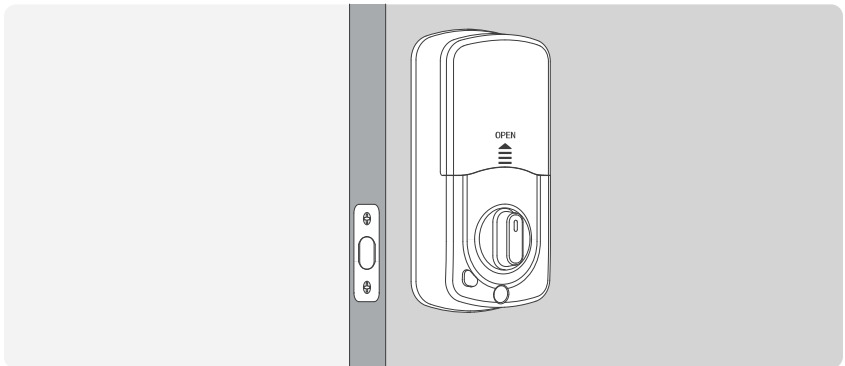



Test the Lock

1. Keep the door open.
2. Turn the knob several times to check whether the deadbolt extends and retracts smoothly.

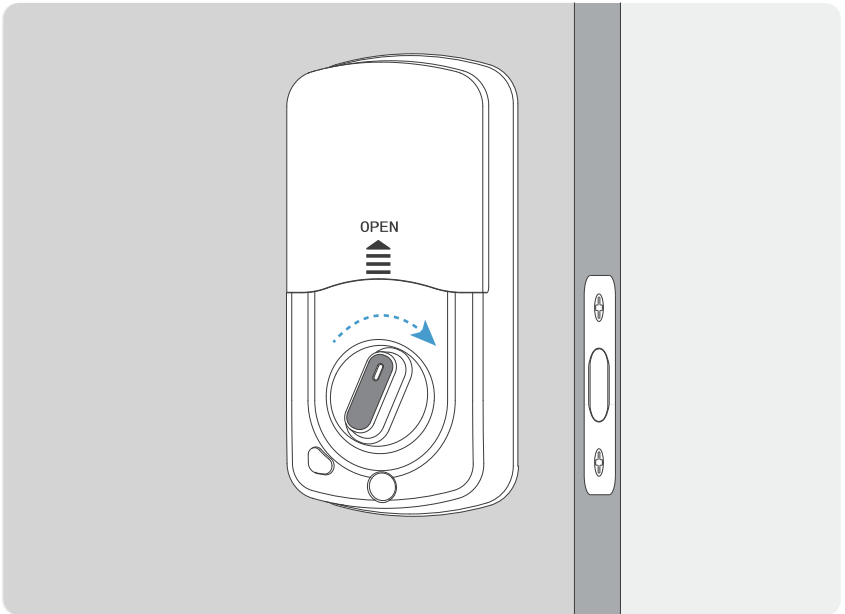



Using the App

1. Create an Account

Android: Search Smart Life on Google Play.

iOS: Search Smart Life on the App store.

Sign up and log into your account with an email address.



2. Pair Your Phone with the Smart Lock

Step 1: Touch the keypad to wake up the lock first, then tap **Add Device**.

Step 2: Add the lock discovered.

Step 3: Name the lock and Tap Done.

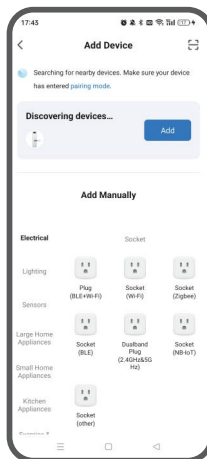
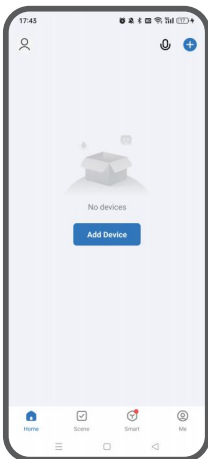



3. Determine the Door Opening Direction

Settings→Unlock Direction→Choose Left / Right

Face the touchscreen, and locate your door hinge.

Select **Left** for the door with hinges on the left.

Select **Right** for the door with hinges on the right.

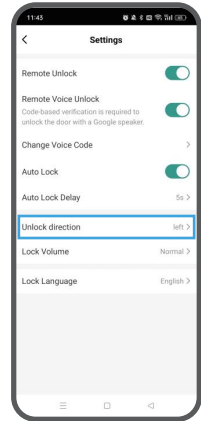

4. Change the Admin Passcode

- Once the lock and your phone are paired, the default admin passcode 123456 is invalid.
- Tap **Member Management**→**Admin**→**Add Code**→Enter a 6-8 digit password and set a code name.

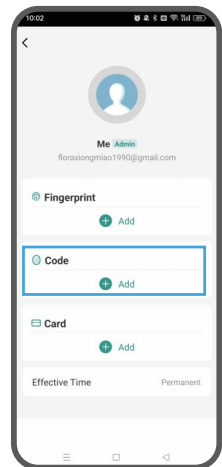
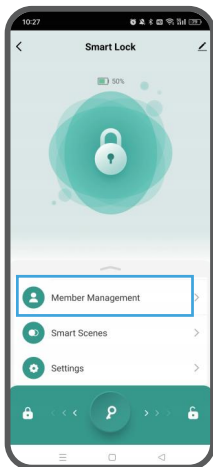



5. APP Homepage Overview

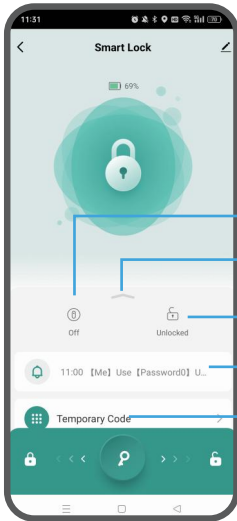

Double Locking On/Off

Tap here to check more

Lock Status

Lock Activities

Manage and set guest passcodes

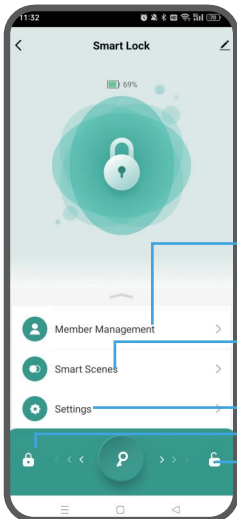

Set passcodes and fingerprints for the admin and family members.

Receive notifications when family members go home or the door lock alarms.

Check and change lock settings.

Swipe to Lock

Swipe to Unlock



(1) Temporary Code

Time-Limited	Use it at least once within 24 hours after it takes effect. Otherwise, it becomes invalid.
One-Time	Validity period: 6 hours. It can be used only once before it expires.
Dynamic	Validity period: 5 minutes. It can be used multiple times before it expires.
Clearing	Choose to delete one/all used time-limited codes. Validity period: 24 hours. Once entered on the lock, one/all used time-limited codes are deleted.
Custom	To set/generate a custom code, your phone must be within 5 meters of the lock if not paired with the gateway.

Note: For security reasons, temporary passwords are invisible once set, so please remember the temporary codes you set.

(2) Set Fingerprints (up to 100)

Tap **Member Management** → **Admin** → **Add Fingerprint** → Follow the on-screen instructions to add a fingerprint.

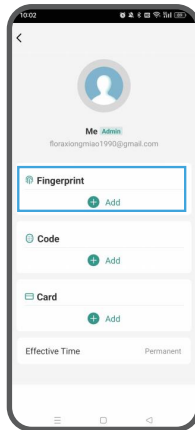
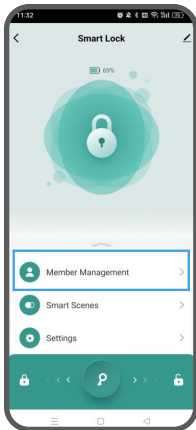

To recognize your fingerprints better:

1. Make sure the fingerprint sensor and your finger are clean and dry.
2. Place your finger on the fingerprint sensor. Move your finger around to capture different parts of it.



(3) Add Card (up to 100)

Tap Member Management→Admin→Add Card→Follow the on-screen instructions to add a card.

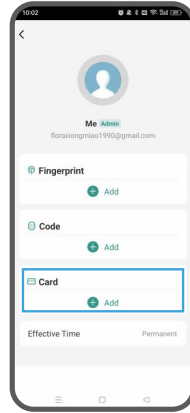
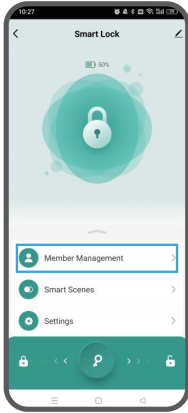

(4) Auto Lock & Remote Unlock

- [Settings](#)→[Auto Lock Delay](#) (Change the interval from 5s-30min as needed)
- [Settings](#)→[Remote Unlock](#)

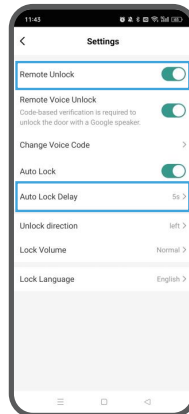
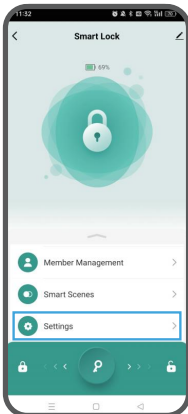



(5) Add Member

- The home owner taps **Me**→**Home Management**→**Your Home**→**Add Member**→**Tap Copy/Messages**→Send the invitation code to the recipient.
- The recipient taps **Me**→**Home Management**→**Join a Home** and enter the invitation code.

Once the recipient be a home member, you can change the family role of the recipient.

Common member: Use device, use smart setting.

Administrator: Manage device and room, manage smart setting, manage member.

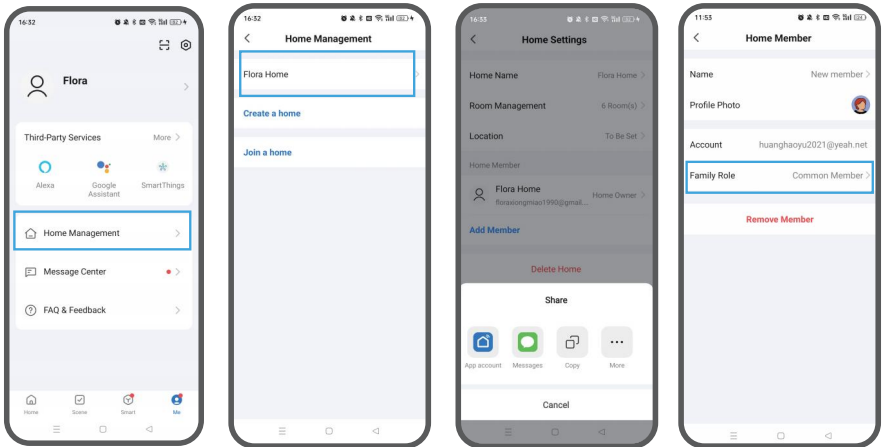



Basic Operations

Unlock the Door

Option 1: Light up the keypad first, then enter the passcode you've set and press the # key to unlock the door. For example: 146585#

Option 2: Unlock the door with your fingerprint.

Option 3: Swipe the IC card to unlock the door.

Option 4: Use the mechanical key.

Option 5: Unlock your door with voice commands using Alexa or Google Home (Gateway Required).

Option 6: Unlock the door via App.

Option 7: Remotely unlock the door via App, if the gateway is paired.

Lock the Door

Option 1: Touch the # key to lock the door.

Option 2: Use the mechanical key.

Option 3: Lock the door via App.

Option 4: Enable auto-lock in the App, the door automatically locks after the set time.

Option 5: Remotely lock the door via App, if the gateway is paired.



How to Reset the Lock

Method A:

- ① Touch and light up the keypad first, then remove one battery from the compartment, wait for 3 seconds and put it back in, the keypad lights up.
- ② Press and hold the double locking button for 10-15 seconds until you hear the voice prompt " Initialization successful" , the reset is complete.

Double Locking Button

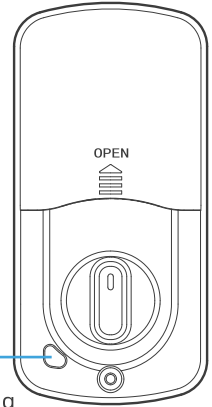

Method B:

- ① Remove the batteries from the battery compartment.
- ② Remove the 3 screws from the back panel.
- ③ Insert the batteries into the battery compartment.
- ④ Press and hold the reset button on the circuit board until you hear the voice prompt " Initialization successful" , the reset is complete.

Note: Keep the cable connected and batteries properly installed.

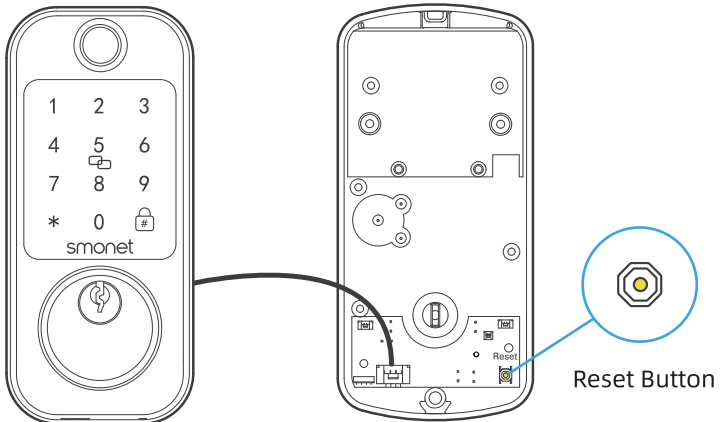



Smart Home Integration

Enable the Gateway

For remote control, add the lock to the App first, and then proceed with the steps below.

Step 1: Plug in the gateway, the blue indicator remains solid and the red indicator flashes slowly.

(If not, press and hold the reset button of the gateway about 10 seconds until the blue indicator remains solid and the red indicator flashes slowly.)

Step 2: Add the Gateway to the App (Pic 1-5). Once the Gateway is successfully added, the red indicator of the Gateway stops flashing and remains solid.

Step 3: Pair the gateway with your smart lock (Pic 6-9).

Notes:

1. Only support 2.4GHz WiFi network, the Gateway enables you to remotely control your lock via the Smart Life App.
2. For best performance, place the Gateway within 5m/16ft from the smart lock and router.

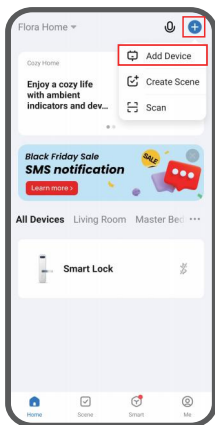

①

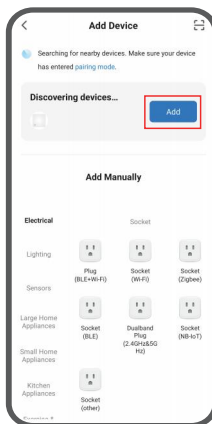

②

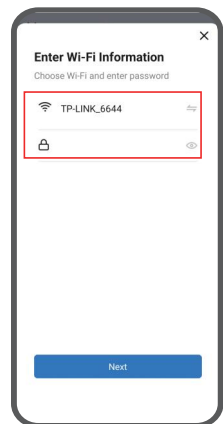

③

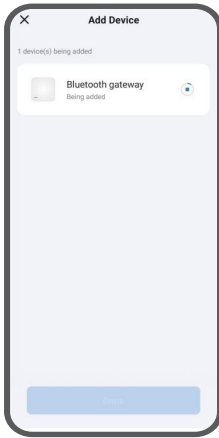

④

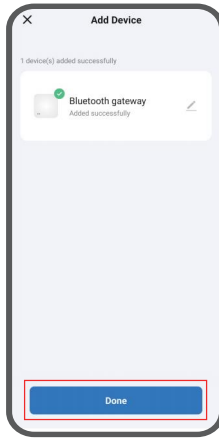

⑤

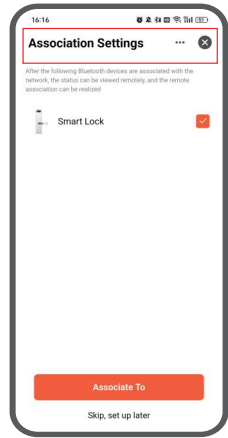

⑥

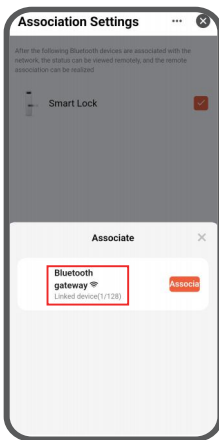

⑦



⑧

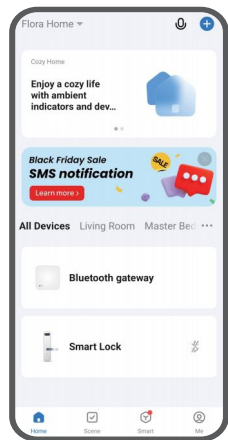

⑨

Note: If you ignored the step 3, you can follow the steps below.

Find the gateway on the homepage of Smart Life App→Tap Gateway→Add device→Add existing→Choose your smart lock→Wait for the gateway to establish a connection with the smart lock.



Enabling Amazon Alexa (Gateway Required)

Step 1: Ensure that the lock and gateway are paired, then enable **Remote Unlock** in the lock **Settings**.

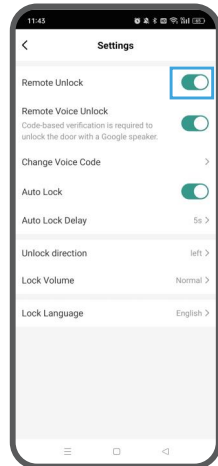
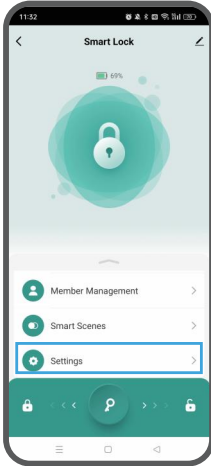

Step 2: Tap **Me** → **Alexa**, then follow the on-screen instructions to complete the setup.

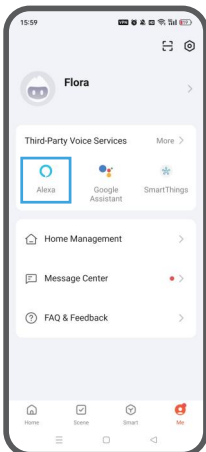



Step 3: Enable **Unlock by App** and **Unlock by voice** in the Alexa App

Tap **Locks**→Select your lock→Tap the **Settings** icon→Enable **Unlock by App** and **Unlock by voice**.

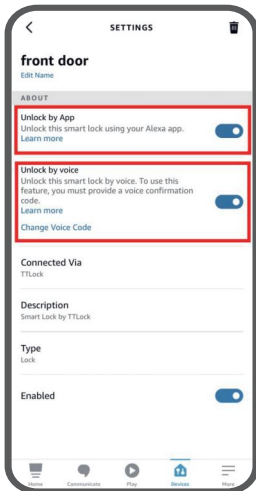
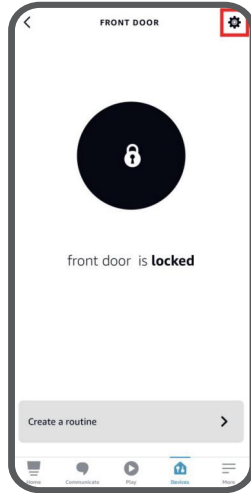
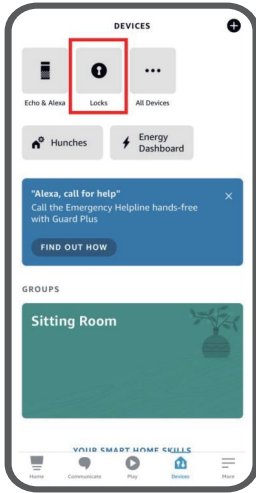



Enabling Google Home (Gateway Required)

Step 1: Pair the Gateway with the lock first, then enable **Remote Voice Unlock** and set a 4-6 digit security code. Google will ask you for this security code when you unlock your door using voice commands.

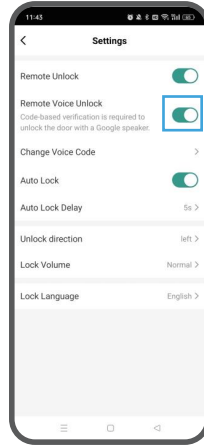
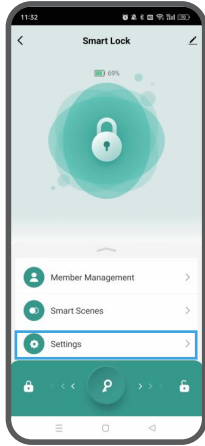

Step 2: Tap **Me** → **Google Assistant**, then follow the on-screen instructions to complete the setup.

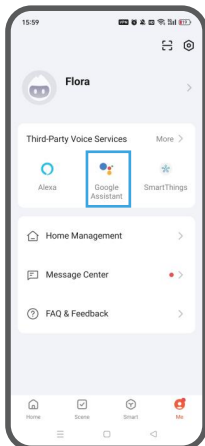



FAQS

How to lock or unlock the door?	Refer to the Basic Operations→Lock the Door & Unlock the Door (Page 17)
How can I share access to the lock with my family and friends?	Refer to the part “Add Member” for details. (Page 16)
How to set/change the Admin passcode?	Go to Member Management → Admin → Code . (Make sure the Bluetooth is on and your phone is within 5 meters of the lock).
How to enter the passcode on the keypad?	Touch and light up the keypad, then enter the passcode you've set and press the # key to confirm.
Can the lock sound be muted?	Stand nearby the lock, turn on your phone's Bluetooth and open the App, tap Settings → Lock Volume → Mute
How to prevent prying eyes?	Simply add extra digits before or after your real passcode and the smart lock will still unlock.
How to double lock your door?	Press and hold the double locking button for 5 seconds, the door is double locked.
How to cancel double locking?	Short press the double locking button or unlock the door by turning the knob/ using the admin App/ admin passcode/ mechanical key.
How to pair the lock with the gateway?	Please refer to the manual in the Gateway box for detailed steps, or contact Customer Service for assistance.

Smart Lock Table

Model	Unlocking Methods				
	App	Passcode (Up to 100)	Fingerprint (Up to 100)	IC Cards (Up to 100)	Keys
M6-BF	√	√	√	√	√



Customer Service

All SMONET products come with lifetime support. Feel free to contact us if you have any questions.

Toll free: 1-888-668-0598

Mon-Sun: 12 pm-8 pm, 9 pm-6 am (EDT)

Email: smonetsmart@hotmail.com

WhatsApp

